

v4枯渇Task Force 教育・テストベッドWorking Group  
大規模ISP  
試験環境図

2010年3月

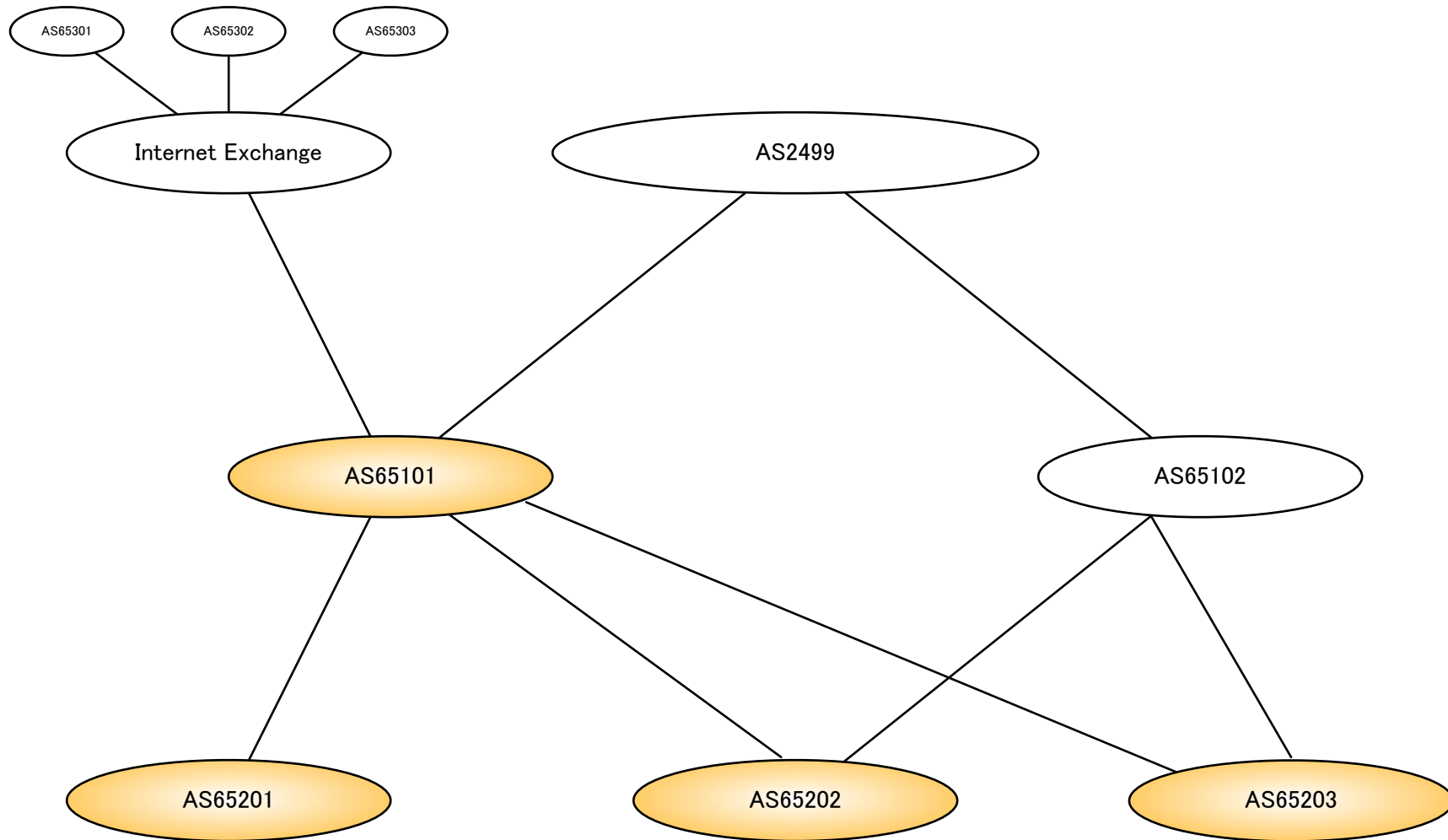

試験環境図	全体概念図	
2010/01/22	Version 1.0	<i>Confidential</i>

メモ  
peer用-1(AS65301): Dual Stack  
peer用-2(AS65302): IPv4 Only  
peer用-3(AS65303): IPv6 Only

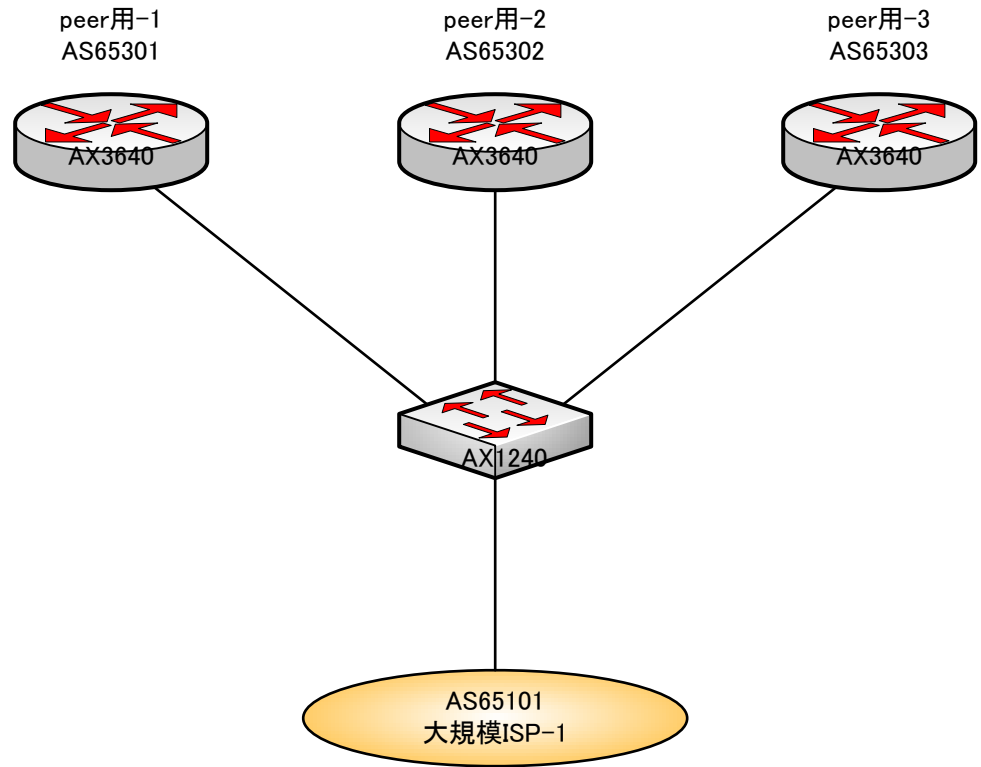

試験環境図	IX 物理構成図	
2010/01/22	Version 1.0	Confidential

メモ  
peer用-1: Dual Stack  
peer用-2: IPv4 Only  
peer用-3: IPv6 Only

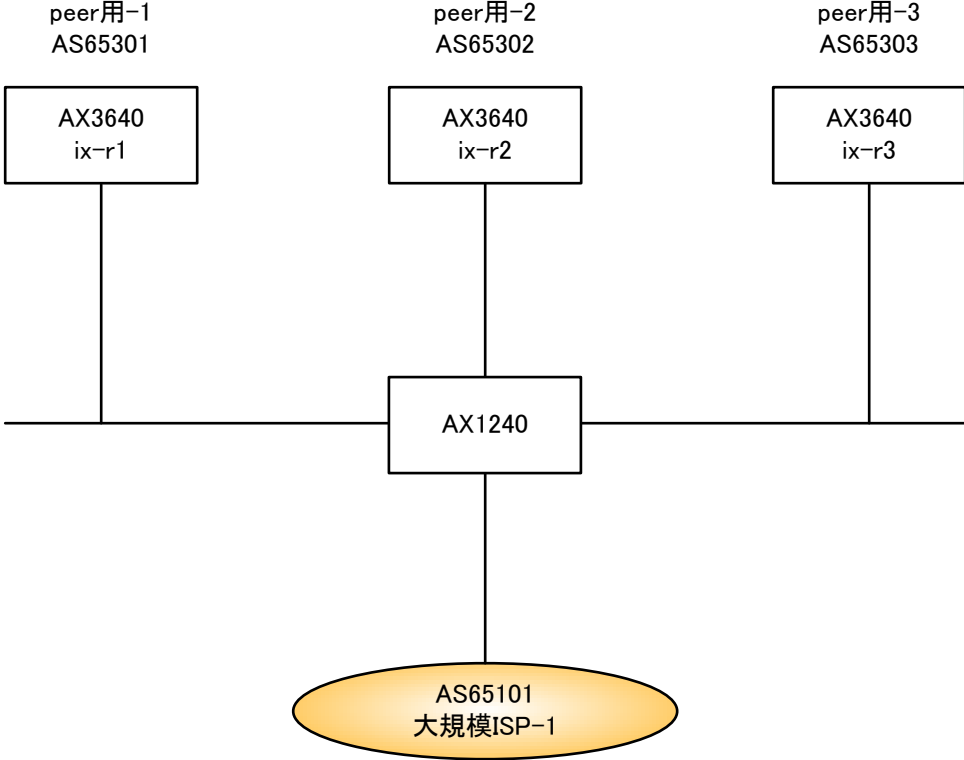

試験環境図	IX L2図	
2010/01/22	Version 1.0	Confidential

メモ

peer用-1: Dual Stack  
peer用-2: IPv4 Only  
peer用-3: IPv6 Only

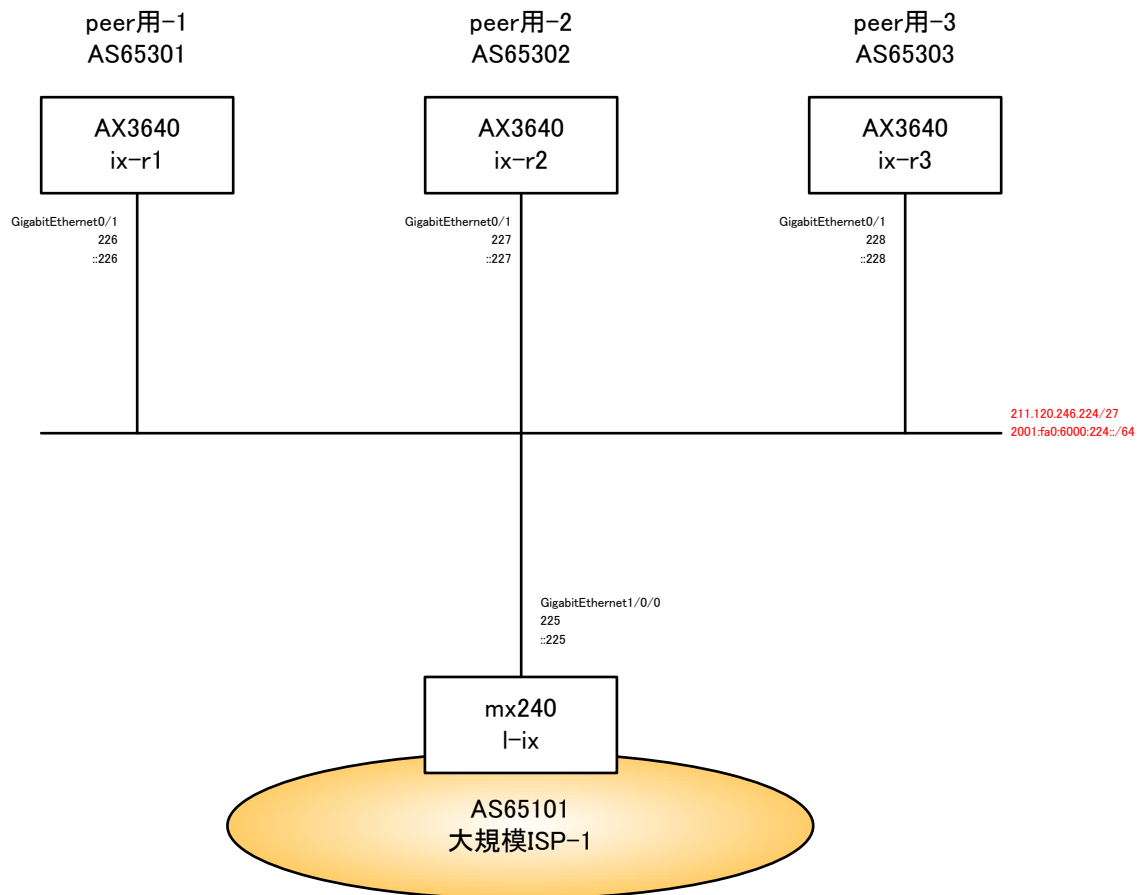

試験環境図	IX L3図	
2010/01/22	Version 1.0	Confidential

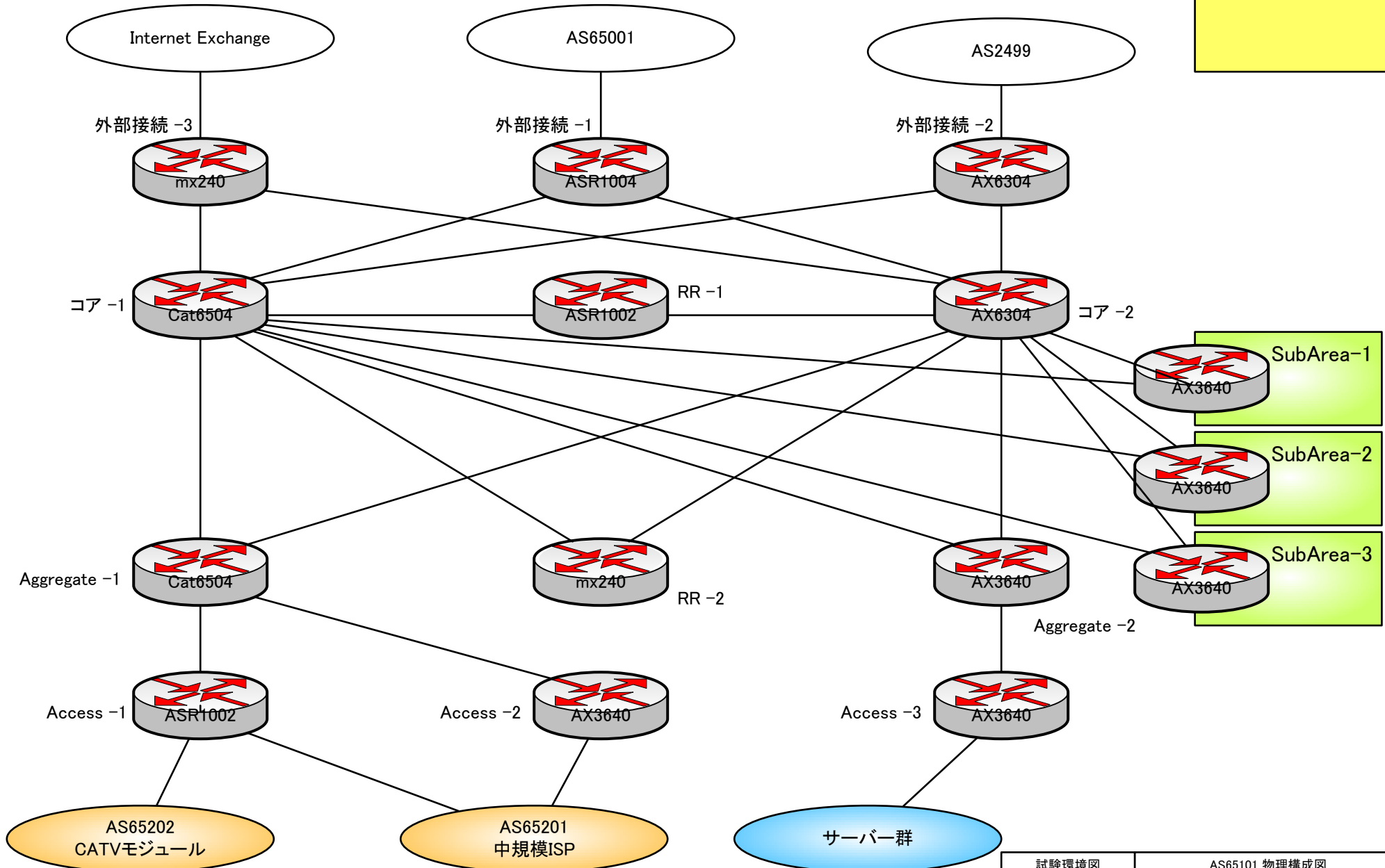

**メモ**  
 大規模ISP移行実験用環境  
 サブエリアはL2図-2を参照

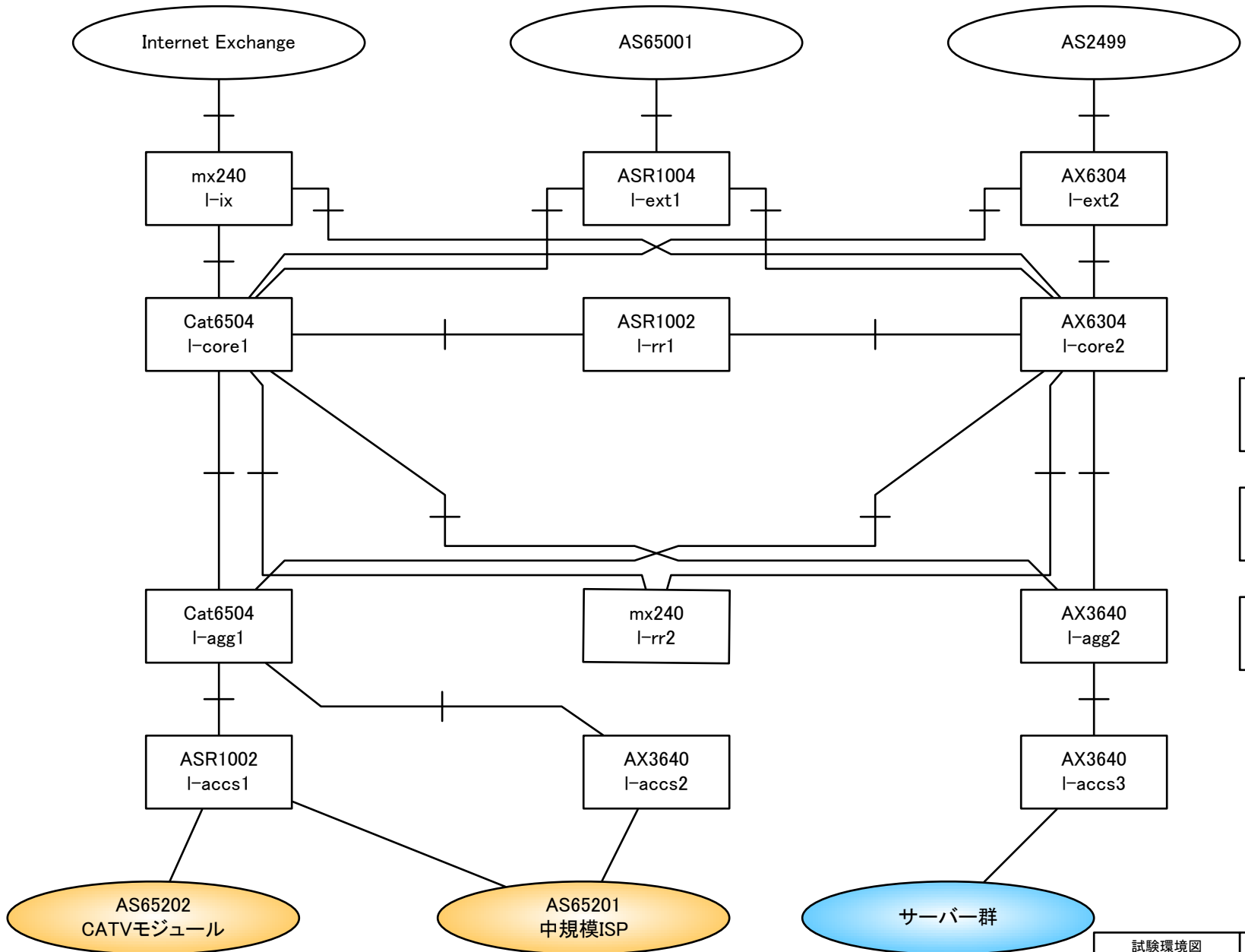

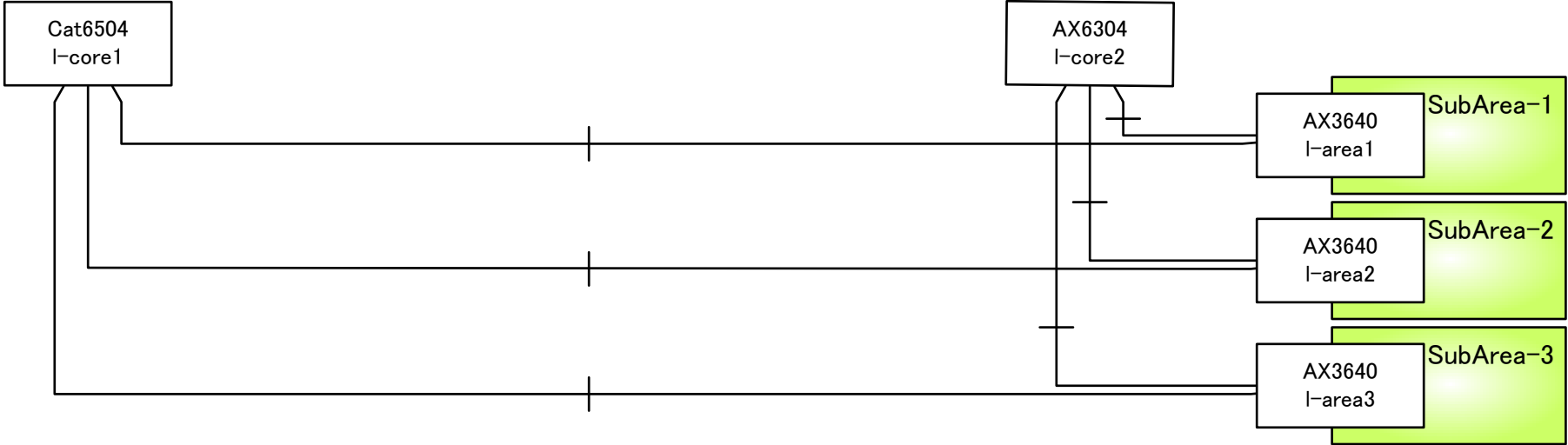



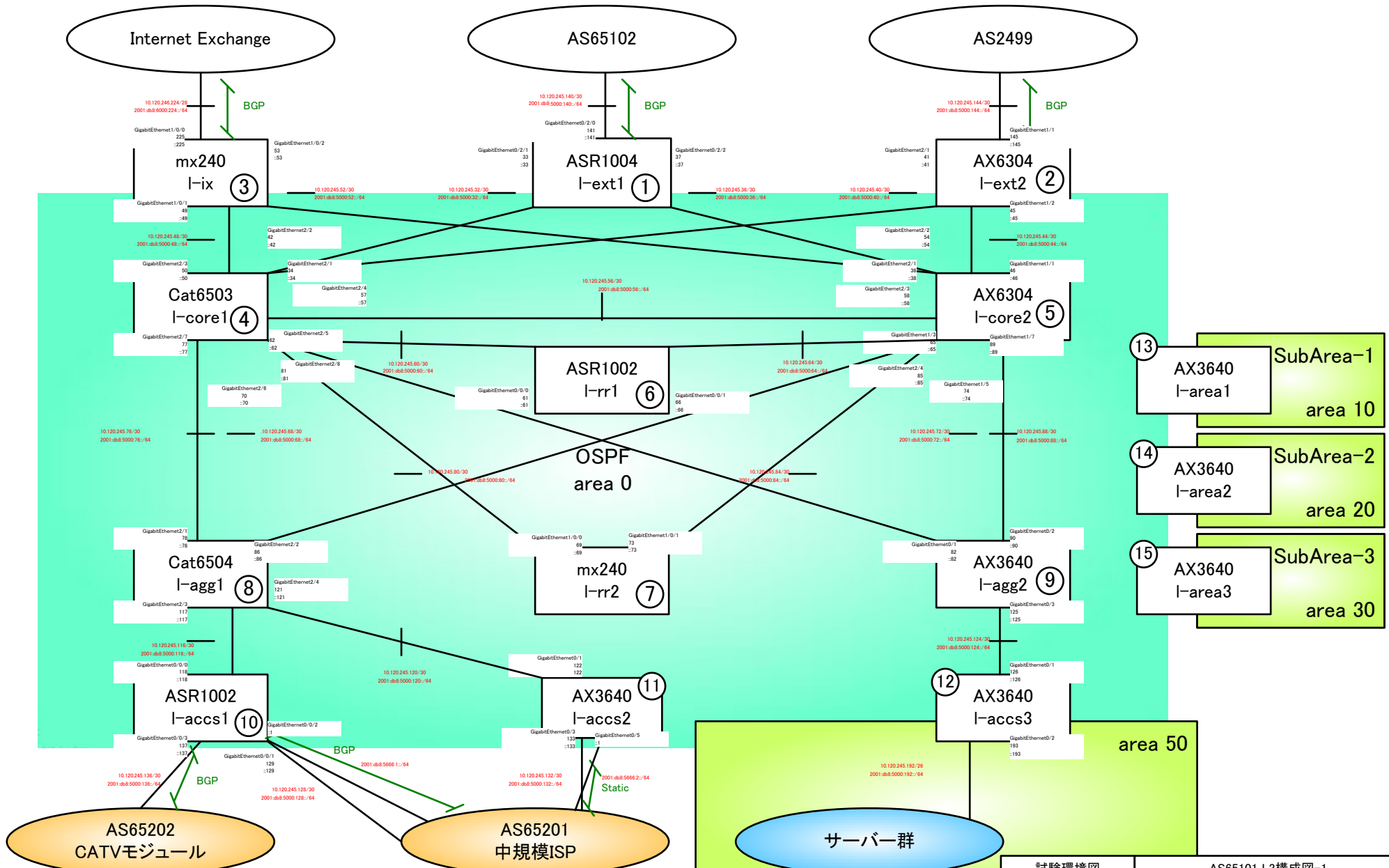

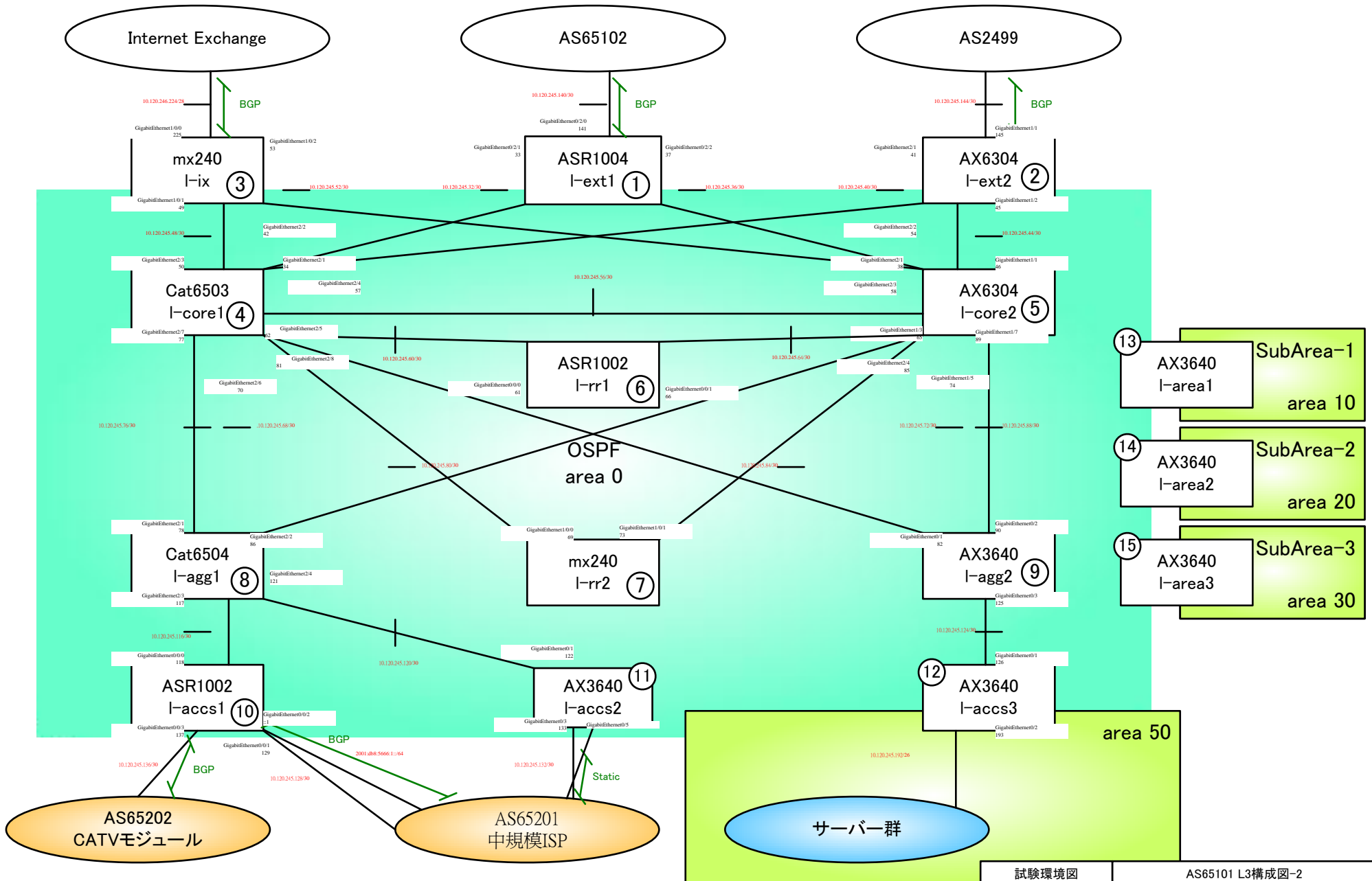

試験環境図	AS65101 L3構成図-2	
2010/01/22	Version 1.0	<i>Confidential</i>

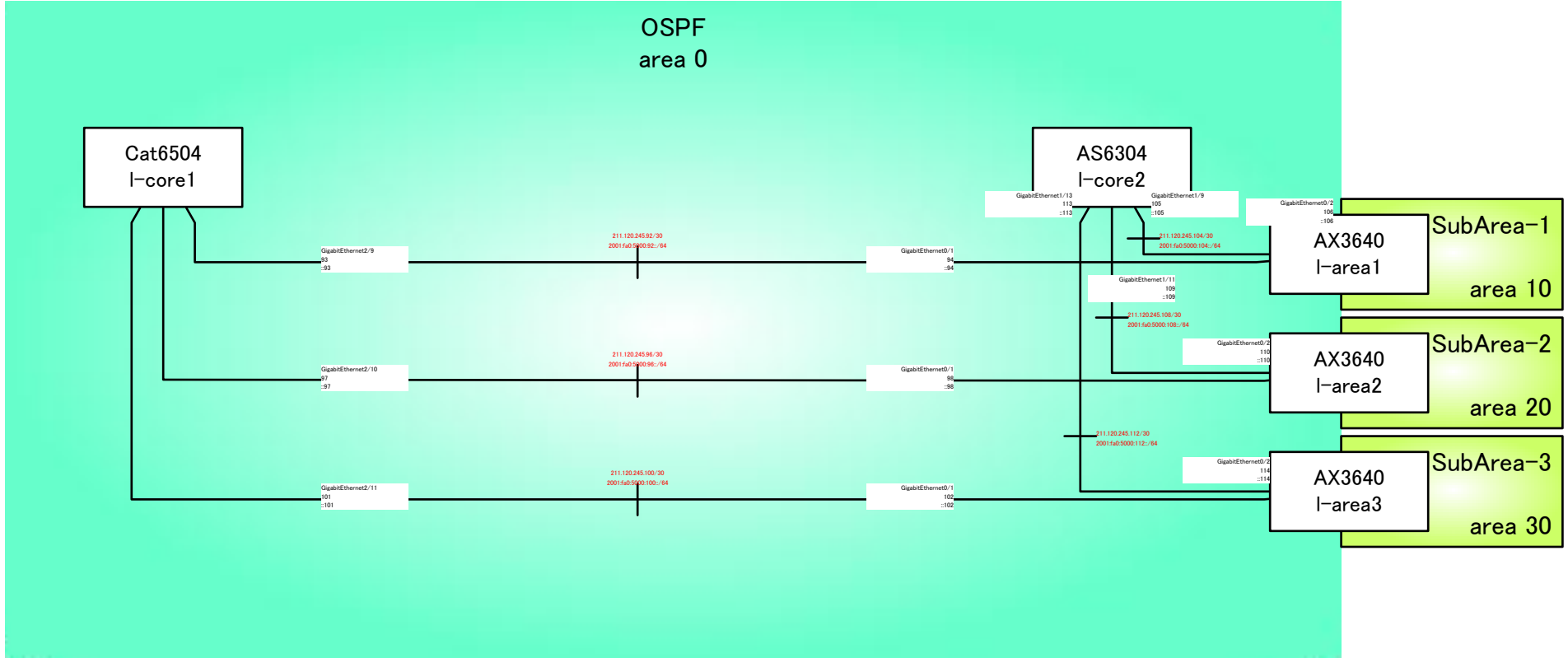

メモ  
AS65201に対してMultihome環境を提供するた  
めだけに存在するAS

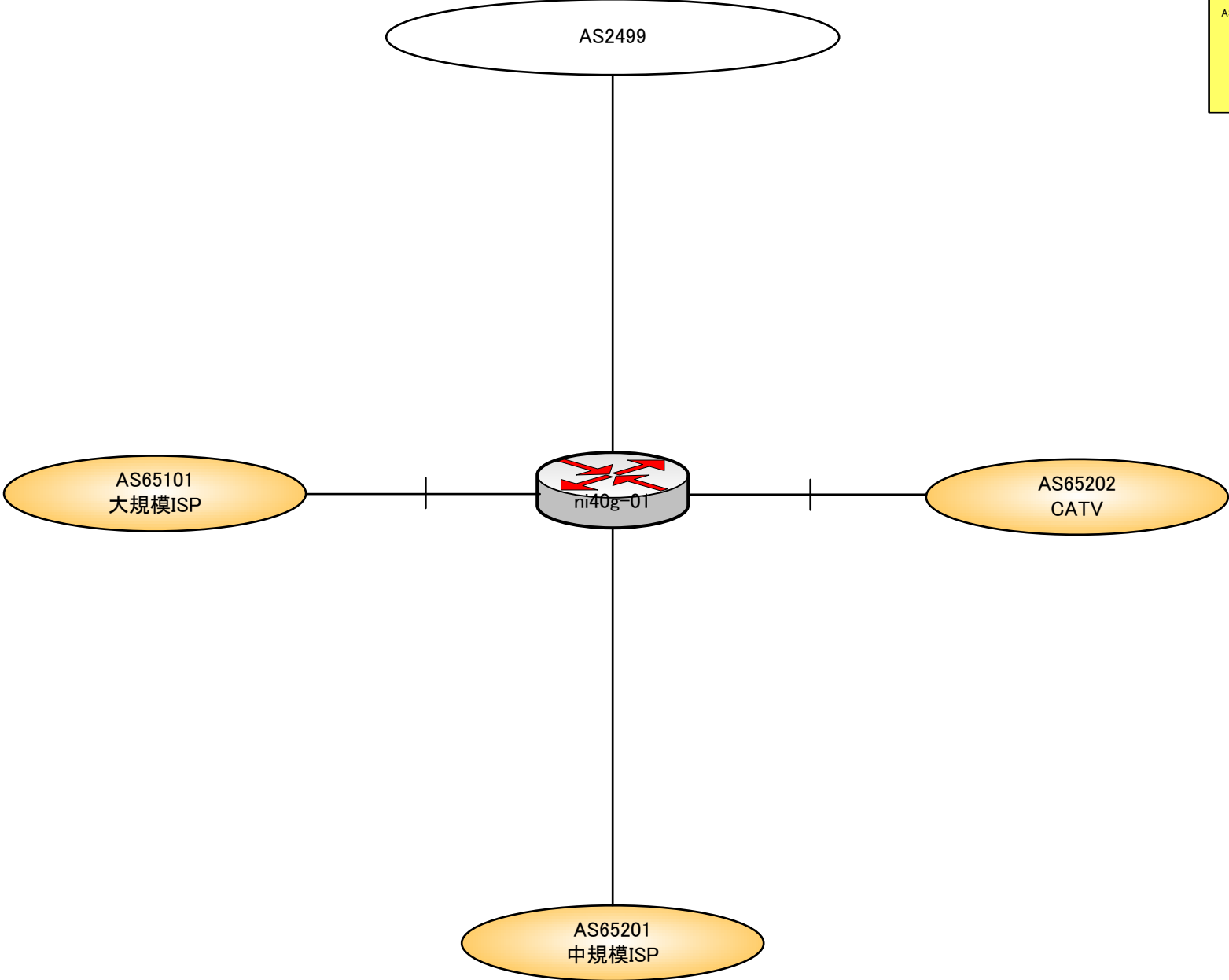

試験環境図	AS65102 物理構成図	
2010/01/22	Version 1.0	Confidential

メモ  
AS2499とPeerしてfull routeを受け取る  
AS65201とpeerして、Full routeを渡す  
この段階ではv4 only

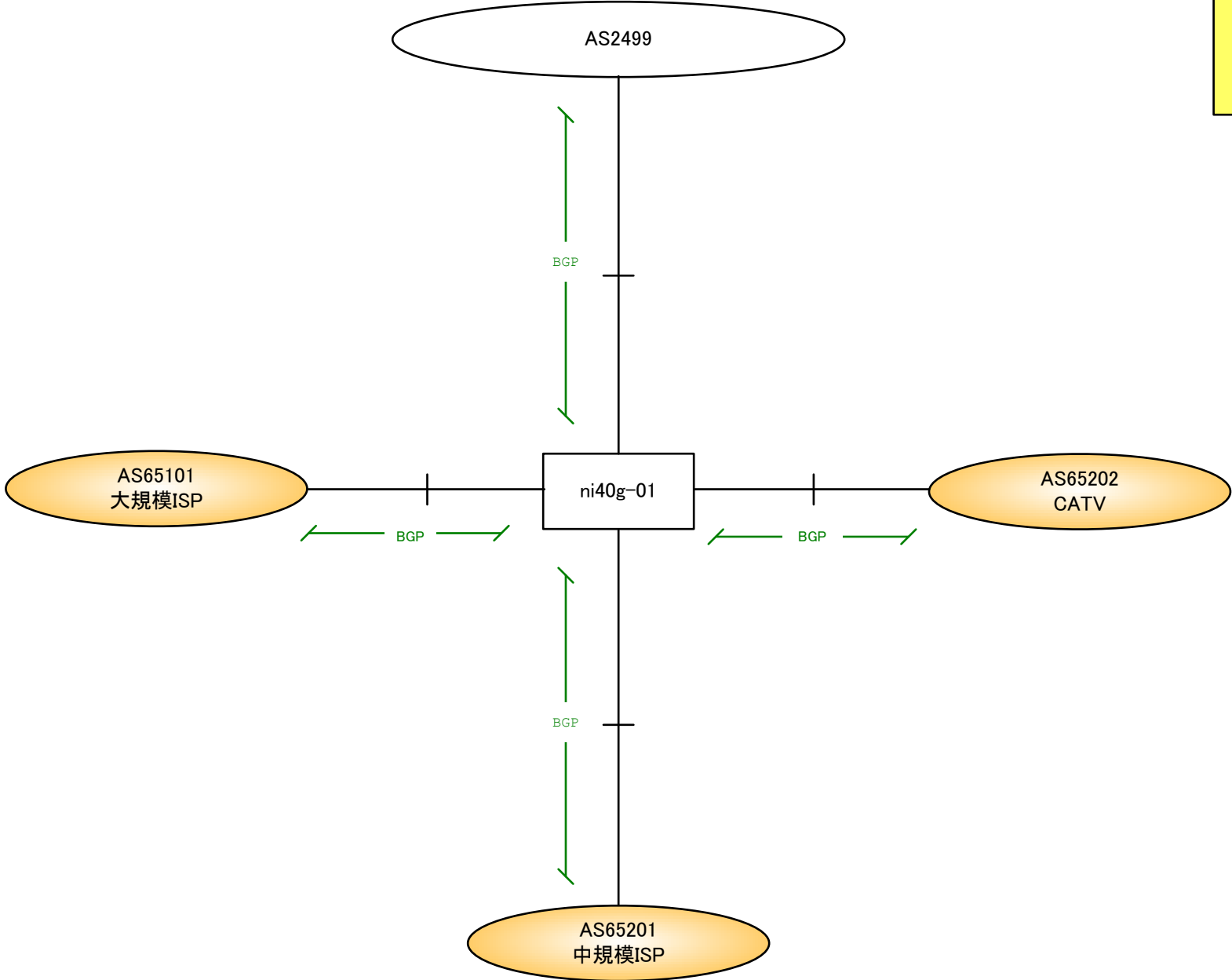

試験環境図	AS65102 L2構成図	
2010/01/22	Version 1.0	Confidential

# メモ

AS2499とPeerしてfull routeを受け取る  
AS65201とpeerして、Full routeを渡す  
この段階ではv4/v6

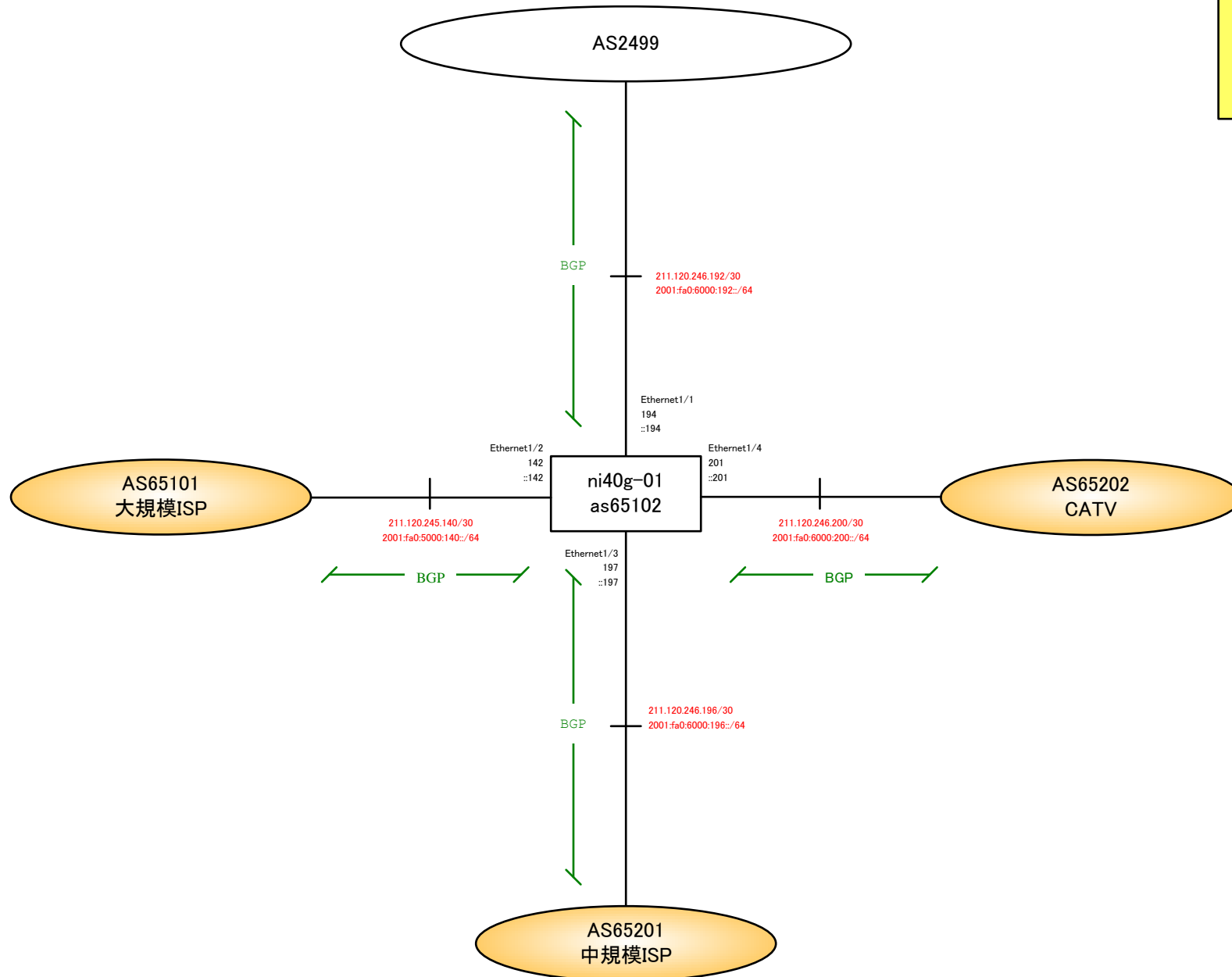

試験環境図	AS65102 L3構成図	
2010/01/22	Version 1.0	Confidential